

• **Hinges Per Door**

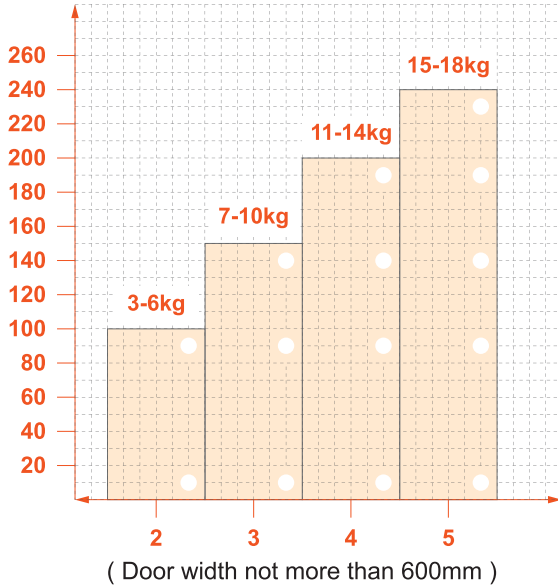

• **Door Adjustment**

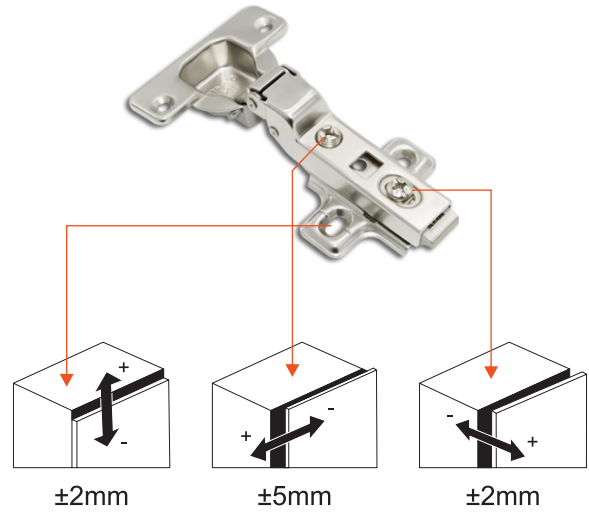

• **Drilling Centers**

Frameless

Face-Frame

D	H	K	3	4	5	6	7
0			8	9	10	11	12

H: Mounting plate height K: Distance from door edge to the edge of cup drilling D: Door overlay on side panel

